

LIBERTY SPARE PARTS (DISCONTINUED) - MARCH 2025

Door Parts

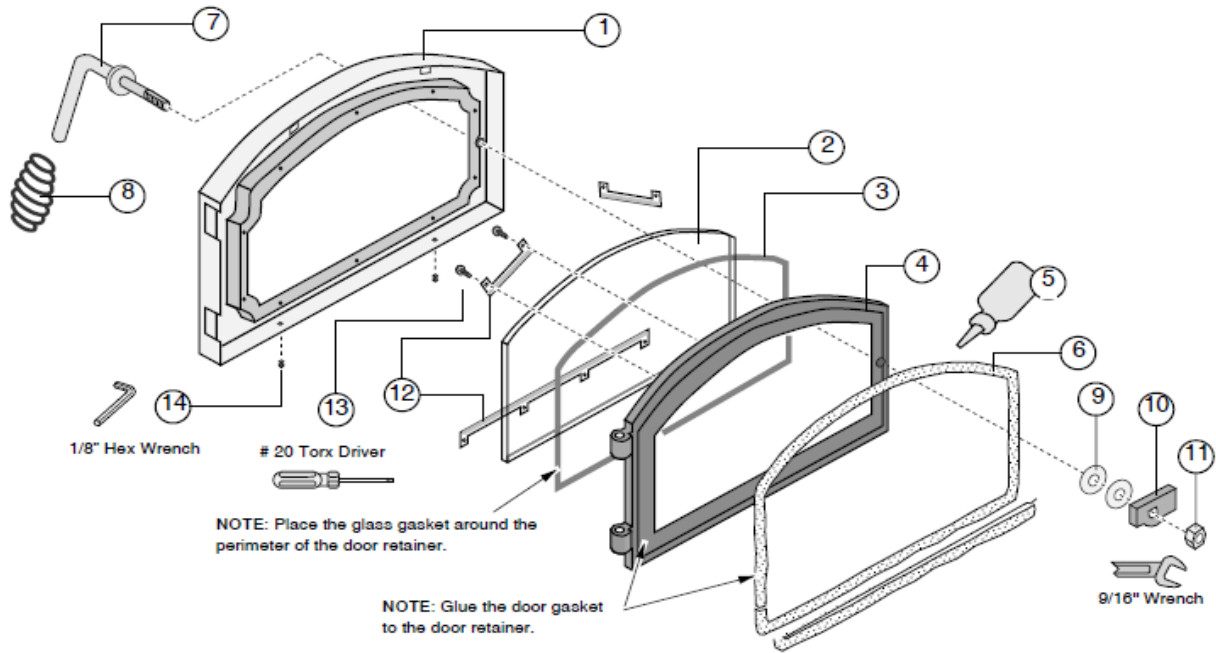

Pricing shown excludes freight and installation. Pricing may vary depending on area.

Pricing includes GST.

ID #	Description	Qty	Part #	\$	Other Detail
1	Door Shell - Black	1	250-02703	\$ 999	
2	Glass (19-1/4" X 9-7/8")	1	250-00462	\$ 260	
3	Glass Gasket	1	224-11086	\$ 75	
3, 4	Glass Retainer with Gasket	1	250-00787	\$ 305	
2,3,4,6	Glass Retainer with Gasket and Glass	1	224-23029	\$ 475	
5	Gasket Cement				See your LOPI Dealer
6	Door Gasket	1	99900406	\$ 85	
7,8,9,10,11	Door Handle Assembly - Black	1	224-14042	\$ 109	
8	Spring - Black	1	250-00373	\$ 15	
9	Washers	2	250-00364	\$ 8	Pack of 8
10	Door Cam	1	250-00599	\$ 64	
11	Hex Nut, Steel 3/8-16 -Jamb-Lock	1	250-00966	\$ 15	Pack of 4
12	Glass Clips with Gasket and Screws - Top	2	250-00914	\$ 26	Each
12	Glass Clips with Gasket and Screws - Bottom	1	250-01374	\$ 41	
13	#8-32 3/8" Type F Screw	8	225-20039	\$ 15	Pack of 8
14	Set Screw (2)	1	225-20038	\$ 8	Pack of 2

Replacing the Glass



The glass must not contact the door or glass clips directly. The glass gasket and glass clip gaskets insulate the glass to prevent cracking. Do not over-tighten the glass clips.

Place the door front side down. Insert the glass gasket into the groove along the inside perimeter of the door. Place the glass on top of the gasket and secure with the glass clips.

Replacing the Door Gasket

The door gasket inserts into the outer groove of the door and is secured with RTV high-temperature 600° silicone. Before installing, remove any residual silicone. Lay the gasket in place (start at the lower left corner) and cut off any excess gasket (do not stretch the gasket). The cement fully cures with heat from the stove. You may need to open and close the door repeatedly to get the gasket to seat fully.

Replacing the Door Handle

See the illustration above for a component list (see pg. 28 for details on adjusting the door).

Firebox Parts

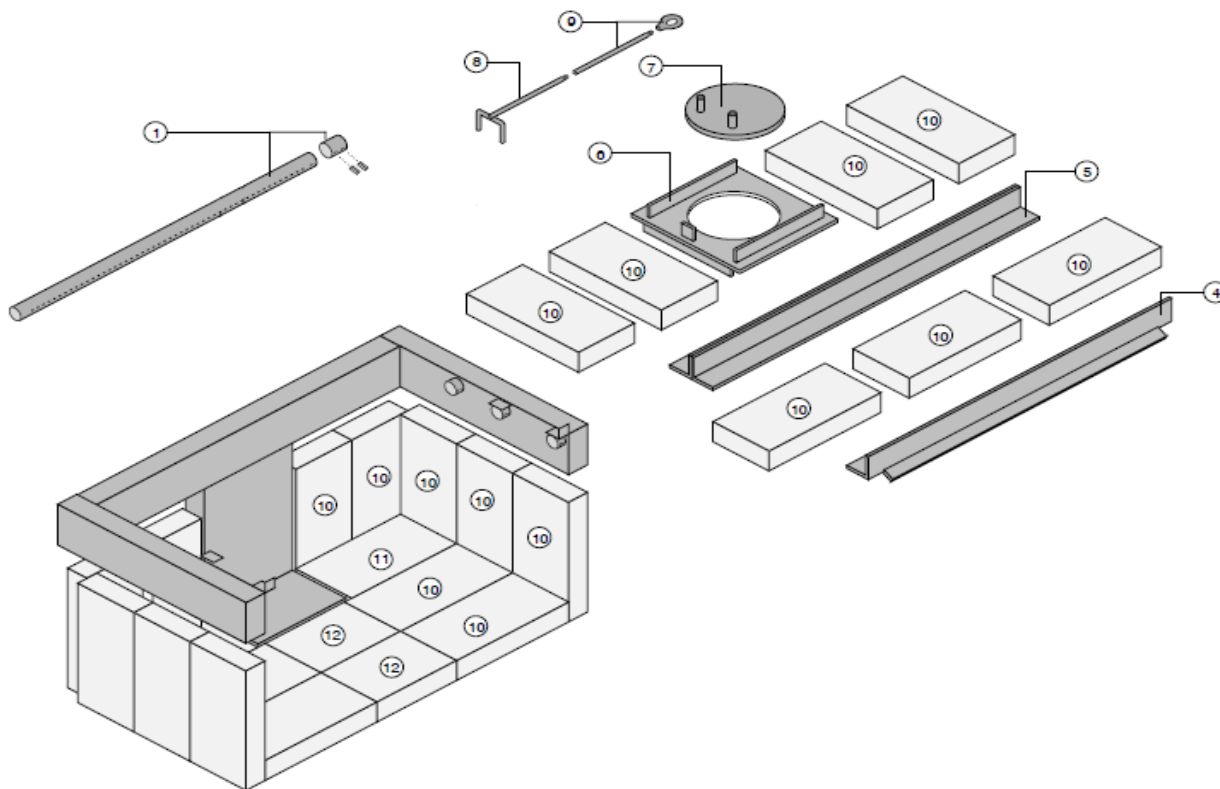

Pricing shown excludes freight and installation. Pricing may vary depending on area.

Pricing includes GST.

ID #	Description	Qty	Part #	\$	Other Detail
1	Air Tube with Sleeve and Roll Pins	1	98900210	\$ 73	
4	Baffle Support, Front "Y"	1	99900277	\$ 83	
5	Baffle Support, Front "T"	1	99900278	\$ 105	
6	Damper Plate	1	98900320	\$ 124	
7	Damper Slider	1	98900340	\$ 70	
8	Damper Yoke	1	98900326	\$ 53	
9	Damper Extension Rod with Pull Ring	1	98900333	\$ 68	
10	Brick - 9" x 4.5" uncut (Single)	21	251-00000	\$ 27	Each
10	Brick - 9" x 4.5" uncut (Box of 8)		99900102	\$ 100	Per Box of 8
11	Brick - 8.25" x 4.5" cut	2	251-00010	\$ 27	Each
12	Brick - 6.25" x 4.5" cut	2	251-00011	\$ 27	Each

Floor and Side Firebrick Removal & Replacement

Do not pry firebrick - they chip and crack easily. Remove the floor firebricks first. The side firebricks are removed later because they are pinned in place by the floor firebrick. Clean the firebox prior to replacing the firebrick.